

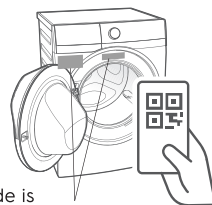

**Enjoy peace of mind.  
Register your appliance today.**

Stay updated on better living services,  
safety notices and shop for accessories.

- 1. Open the camera app on your smartphone and point at the QR code to scan.**



Product Registration QR code is located on the front of your appliance or inside the door rim.

- 2. Tap the notification or link to open the registration form.**

- 3. Complete your details and enjoy peace of mind.**

## IMPORTANT INFORMATION THAT MAY IMPACT YOUR MANUFACTURER'S WARRANTY

Adherence to the directions for use in this manual is extremely important for health and safety. Failure to strictly adhere to the requirements in this manual may result in personal injury, property damage and affect your ability to make a claim under the Electrolux manufacturer's warranty provided with your product. Products must be used, installed and operated in accordance with this manual. You may not be able to claim on the Electrolux manufacturer's warranty in the event that your product fault is due to failure to adhere to this manual.

## WE'RE THINKING OF YOU

Thank you for purchasing an Electrolux appliance. You've chosen a product that brings with it decades of professional experience and innovation. Ingenious and stylish, it has been designed with you in mind. So whenever you use it, you can be safe in the knowledge that you'll get great results every time. Welcome to Electrolux.

**Visit our website to:**



Get usage advice, brochures, troubleshooting, service information, buy accessories & spare parts, online product registration : [www.electrolux.com](http://www.electrolux.com)

## CUSTOMER CARE AND SERVICE

We recommend the use of original spare parts. When contacting Service, ensure that you have the following data available. The information can be found on the rating plate. Model, PNC, Serial Number.

 Warning / Caution-Safety information.

 General information and tips.

 Environmental information.

Subject to change without notice.

## CONTENTS

### 1. SAFETY INFORMATION

1.1 Conditions Of Use .....	4
1.2 Child Safety .....	5
1.3 General Safety .....	6
1.4 Installation .....	6
1.5 Use .....	7

### 2. PRODUCT DESCRIPTION

2.1 Parts .....	8
2.2 Accessories .....	9

### 3. CONTROL PANEL

3.1 Control Panel Description .....	10
3.2 Program Chart .....	11
3.3 Program Options Compatibility.....	12
3.4 Options .....	13
3.5 Settings .....	15
3.6 Start/Pause (▷  ) and Add Clothes (⌘) Touchpad .....	16

<b>4. BEFORE FIRST USE</b>	16
<b>5. DAILY USE</b>	
5.1 Loading The Laundry	17
5.2 Using Detergent And Additives	17
5.3 Options Setting	18
5.4 Starting A Cycle (▷  )	19
5.5 Interruption Of A Program	19
5.6 Changing A Program	19
5.7 Changing The Options	19
5.8 Opening The Door	19
5.9 At The End Of The Program	19
5.10 When The Washing Program Is Completed, But There Is Water In The Drum	20
5.11 AUTO Off Mode	20
<b>6. WASHING HINTS</b>	
6.1 Sorting The Laundry	21
6.2 Temperatures	21
6.3 Before Loading The Laundry	21
6.4 Maximum Loads	21
6.5 Removing Stains	21
6.6 Detergents Type And Quantity Of Detergent	22
<b>7. INTERNATIONAL WASH CODE SYMBOLS</b>	23
<b>8. CARE AND CLEANING</b>	
8.1 External Cleaning	24
8.2 Descaling	24
8.3 After Each Wash	24
8.4 Maintenance Wash With "Tub Clean" Program	24
8.5 Cleaning The Dispenser Drawer	24
8.6 Cleaning The Drawer Recess	25
8.7 Cleaning The Pump	25
8.8 Cleaning The Water Inlet Filter	27
8.9 Frost Precautions	28
<b>9. TROUBLESHOOTING</b>	
9.1 Possible Failures	29
9.2 Emergency Door Opening	32
<b>10. TECHNICAL DATA</b>	33
<b>11. INSTALLATION</b>	
11.1 Unpacking	33
11.2 Positioning	35
11.3 Water Inlet	36
11.4 Water Drainage	36
11.5 Electrical Connection	38
<b>12. ENVIRONMENT CONCERNS</b>	
12.1 Packaging Materials	38
12.2 Old Machine	38
12.3 Ecological Hints	38

# 1. SAFETY INFORMATION

## 1.1 Conditions Of Use

This appliance is intended to be used in household and similar applications such as:

- staff kitchen areas in shops, offices and other working environment;
- farm houses;
- by clients in hotels, motels, and other residential type environments;
- bed and breakfast type environments;
- areas for communal use in blocks of flats or in launderettes.

 **WARNING!** The appliance must not be supplied through an external switching device, such as timer, or connected to a circuit that is regularly switched on and off by utility.

In the interest of your safety and to ensure the correct use, before installing and first using the appliance, read this user manual carefully, including its hints and warnings.

To avoid unnecessary mistakes and accidents, it is important to ensure that all people using the appliance are thoroughly familiar with its operation and safety features.

Save these instructions and make sure that they remain with the appliance if it is moved or sold, so that everyone using it through its life will be properly informed on appliance use and safety.

This appliance is designed to work safely within 130-280V, 50Hz. If in your area Voltage fluctuations are beyond this range, you are advised to use suitable Voltage stabilizer/Electrical protection to safeguard the Appliance. Company warranty for appliance not applicable if voltage fluctuates beyond this range.

## 1.2 Child Safety

- This washing machine is not intended for use by young children or infirm persons without supervision.
- Young children should be supervised to ensure that they do not play with the appliance.
- The packaging components (e.g. plastic film, polystyrene) can be dangerous to children - danger of suffocation! Keep them out of children's reach.
- Keep all detergents in a safe place out of children's reach.
- Make sure that children or pets do not climb into the drum.
- This machine is provided with child safety lock option () to prevent children playing with the control panel. (see page 15)

### 1.3 General Safety

- It is dangerous to alter the specifications or attempt to modify this product in any way.
- During high temperature wash program the door glass may get hot. Do not touch it!
- Make sure that small pets do not climb into the drum. To avoid this, please check inside the drum before using the appliance.
- Any objects such as coins, safety pins, nails, screws, stones or any other hard, sharp material can cause extensive damage and must not be placed into the machine.
- Wash small items such as socks, laces, washable belts etc in a washing bag or pillow case as it is possible for such items to slip down between the tub and the inner drum.
- Only use manufacturer's recommended quantities of fabric softener and detergent. Damage to the fabric or appliance can occur if you exceed the recommended amount.
- Do not use your washing machine to wash articles with whalebones, material without hems or torn material.
- Always unplug the appliance and turn off the water supply after use, clean and maintenance.
- This appliance is not intended for use by persons (including children) with reduced physical, sensory or mental capabilities, or lack of experience and knowledge, unless they have been given supervision or instruction concerning use of the appliance by a person responsible for their safety.
- Under no circumstances should you attempt to repair the machine yourself. Repairs carried out by inexperienced persons may cause injury or serious malfunctioning. Contact your local Service Centre. Always insist on genuine spare parts.

### 1.4 Installation

- This appliance is heavy. Care should be taken when moving it.
- When unpacking the appliance, check that it is not damaged. If in doubt, do not use it and contact the Service Centre.
- All packing and transit bolts must be removed before use. Serious damage can occur to the product and to property if this is not adhered to. See relevant section in the user manual.
- After having installed the appliance, check that it is not standing on the inlet and drain hose and the worktop is not pressing the electrical supply cable.
- If the appliance is installed on a carpeted floor, please adjust the feet in order to allow air to circulate freely.
- Always be sure, that there is no water leakage from hoses and their connections after the installation.
- Any plumbing work required to install this appliance should be carried out by a qualified plumber.
- Any electrical work required to install this appliance should be carried out by a qualified electrician.



**May cause electric shock! if the machine is not connected to an earthed/ground system. DO NOT touch the wet clothes and metal parts.**



**For safety reasons do not use double adaptors, extension cords and multi-plug adaptors.**

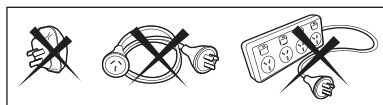

## 1.5 Use

- Only wash fabrics which are designed to be machine washed. Follow the instructions on each garment label.
  - Do not overload the appliance. See the relevant section in the user manual.
  - Before washing, ensure that all pockets are empty and buttons and zips are fastened. Avoid washing frayed or torn articles and treat stains such as paint, ink, rust, and grass before washing.
  - Garments which have been in contact with volatile petroleum products should not be machine washed. If volatile cleaning fluids are used, care should be taken to ensure that the fluid is removed from the garment before placing in the machine.
  - Never pull the power supply cable to remove the plug from the socket; always take hold of the plug itself.
  - Never use the washing machine if the power supply cable, the control panel, the working surface or the base are damaged so that the inside of the washing machine is accessible.
-

## 2. PRODUCT DESCRIPTION

### 2.1 Parts

Worktop

Detergent/Softener  
Dispenser  
(see page 17)

Control Panel  
(see page 10)

Door

Cabinet

Front Panel

Drain Pump Filter  
(see page 25)

Level Adjustment  
Feet (Front)

Transit Bolts

Water Inlet Hose  
(see page 36)

Transit Bolts &  
Hose Support

Mains Cable

Transit Bolts &  
Hose Support

Water Drain Hose  
(see page 36)

Level Adjustment  
Feet (Back)

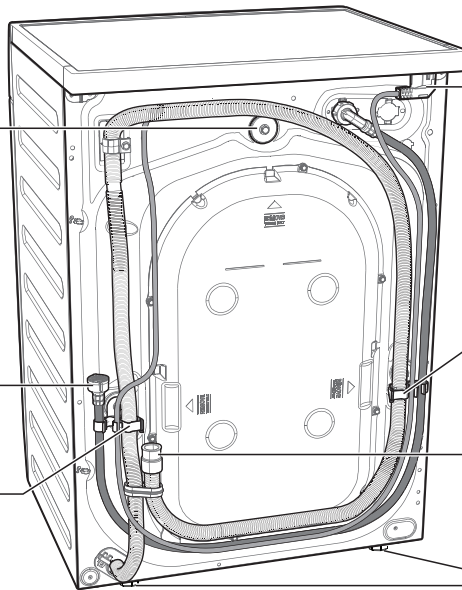
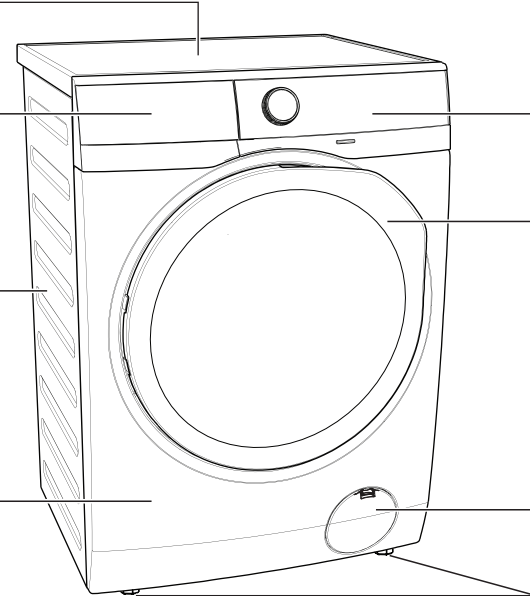

\*For model EWF9024R5WB,  
EWF9024R5SB



**Detergent/Softener Dispenser**  
(For more informations, see page 17, 24)

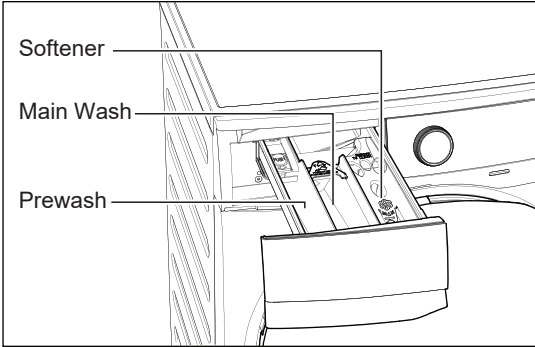

**Door (when open)**  
(for more informations, see page 17)

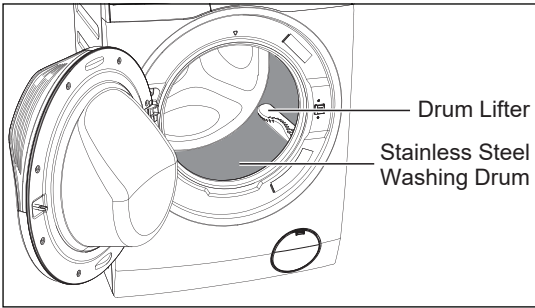

**Drain Pump Filter (when open)**

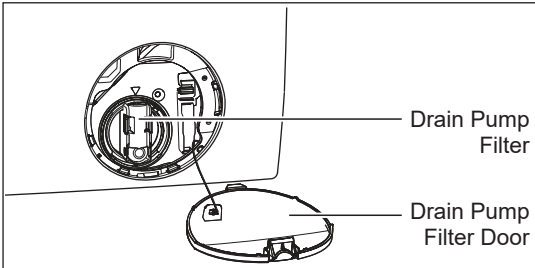

**Level Adjustment Feet**

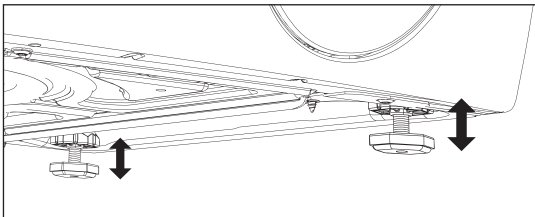

**Transit Bolt (when remove)**

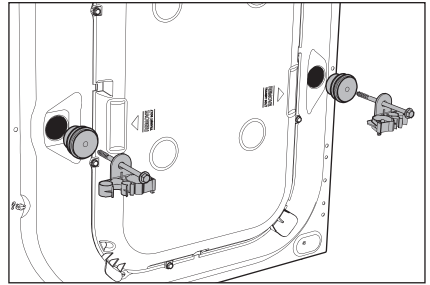
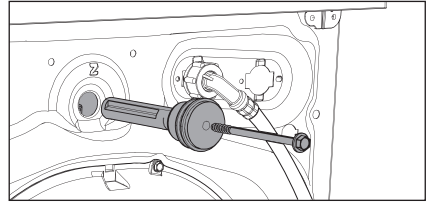

**!** Transit bolts must be removed before using the appliance.

**2.2 Accessories**

**Plastic Caps**

To close the holes on the rear side of the cabinet after the removal of the transit bolts.



**Plastic Hose Guide**

To connect the drain hose on the edge of a sink.

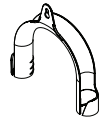

### 3. CONTROL PANEL

#### 3.1 Control Panel Description

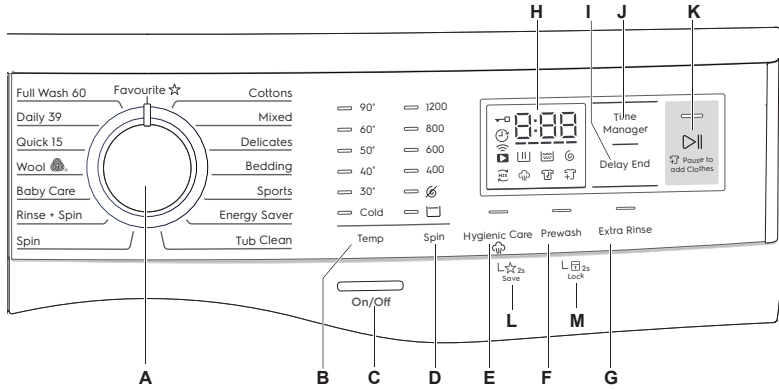

- A** Program knob selector
- B** Temp touchpad
- C** On/Off button
- D** Spin touchpad
- E** Hygienic Care touchpad
- F** Prewash touchpad
- G** Extra Rinse touchpad
- H** Display
- I** Delay End touchpad
- J** Time Manager touchpad
- K** Start/Pause touchpad  
(Pause to add Clothes option)
- L** Favourite program save option
- M** Child safety lock option

#### Display

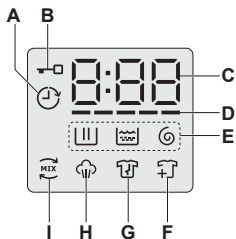

- A** Delay End Icon
- B** Door Lock Icon
- C** Program Duration / Delay End Time / Alarm Code
- D** Time Manager level
- E** Program Phase Indication Icon:  
 ▮▮▮ Wash Phase, ▮▮▮ Rinse Phase,  
 ⚙ Spin Phase
- F** Add Clothes Icon
- G** Anticrease Phase Icon (this program phase is only active in the Washer Dryer model)
- H** Vapour phase Icon
- I** Ultramix phase Icon

### 3.2 Program Chart

Program; Temperature range	Max. Spin Speed	Max. Load (Dry Clothes)	Type of load and soil level
<b>Cottons;</b> Cold to 90°C	1200 rpm	<b>Max. <sup>1)</sup></b>	White and coloured cotton. (Adjust wash time according to soil level. See Time Manager table on page 13)
<b>Mixed;</b> Cold to 60°C	1200 rpm	4 kg	Synthetic or mixed fabric items. (Adjust wash time according to soil level. See Time Manager table on page 13)
<b>Delicates;</b> Cold to 40°C	1200 rpm	4 kg	Delicate fabrics such as acrylics, viscose, polyester items. (Adjust wash time according to soil level. See Time Manager table on page 13)
<b>Bedding;</b> Cold to 60°C	800 rpm	3 kg	Special program for one synthetic blanket, duvet, bedspread and so on. (Adjust wash time according to soil level. See Time Manager table on page 13)
<b>Sports;</b> Cold to 40°C	1200 rpm	4 kg	A gentle program designed for mixed fabrics found in delicate clothes.
<b>Energy Saver;</b> 40°C and 60°C	1200 rpm	<b>Max. <sup>1)</sup></b>	White and colourfast cotton. Set this program to have a good washing results and decrease the energy consumption. The time of the washing program is extended.
<b>Tub Clean;</b> 60°C	–	–	For cleaning the tub.
<b>Spin</b>	1200 rpm	<b>Max. <sup>1)</sup></b>	To spin the laundry and drain the water in the drum.
<b>Rinse + Spin</b>	1200 rpm	<b>Max. <sup>1)</sup></b>	To rinse and spin the laundry.
<b>Baby Care;</b> Cold to 40°C	1200 rpm	4 kg	Baby cotton clothes and delicate knitting items with normal soil.
<b>Wool</b>  ; Cold to 40°C	1200 rpm	1.5 kg	Specially tested program for woollen garments bearing the “Pure new woollen, non-shrink, machine washable” label.
<b>Quick 15;</b> Cold to 30°C	1200 rpm	1.5 kg	Lightly soiled synthetics or mixed fabrics.
<b>Daily 39;</b> 30°C to 40°C	1200 rpm	EWFF8024R5WB, EWFF8024R5SB 4 kg EWFF9024R5WB, EWFF9024R5SB 5 kg	Daily wear coloured cotton clothes such as shirts, blouses, towels and undergarments. Ideal for low level of soil.

Program; Temperature range	Max. Spin Speed	Max. Load (Dry Clothes)	Type of load and soil level
Full Wash 60; 30°C to 60°C	1200 rpm	Max. <sup>1)</sup>	Daily wear coloured cotton clothes such as shirts, blouses, towels and undergarments. Ideal for normal level of soil.
Favourite	–	–	Recall your favourite program.

1) Maximum capacity depended on the model of the Washing Machine (see defined on the control panel)

## WOOLMARK CERTIFICATE









The wool wash cycle of this machine has been approved by The Woolmark Company for the washing of machine washable wool products provided that the products are washed according to the instructions on the garment label and those issued by the manufacturer of this washing machine.

Model EWF8024R5WB, EWF8024R5SB : M1757

Model EWF9024R5WB, EWF9024R5SB : M1758

## 3.3 Program Options Compatibility

Program	Option							
	 No Spin	 Rinse Hold	 Time Manager	 Delay End	 Hygienic Care <sup>1)</sup>	 Prewash	 Extra Rinse	
Cottons	■	■	■	■	■	■	■	
Mixed	■	■	■	■	■	■	■	
Delicates	■	■	■	■	■	■	■	
Bedding	■		■	■	■			
Sports	■	■		■		■	■	
Energy Saver	■	■		■	■	■	■	
Tub Clean								
Spin	■			■				
Rinse + Spin	■	■		■				
Baby Care	■	■		■	■	■	■	
Wool	■	■		■				
Quick 15	■	■		■				
Daily 39	■			■				
Full Wash 60	■	■		■			■	
Favourite								

1) "Hygienic Care" option can be combined with temperature 40 to 90 °C only.



### 3.4 Options

#### Temperature Touchpad



Press this touchpad repeatedly to increase or decrease the wash temperature if you want your laundry to be washed at a temperature different from the one proposed by the washing machine. (Symbol "✱" corresponds to cold wash)

#### Spin Selection Touchpad

Press this touchpad repeatedly to increase or decrease the spin speed or select Rinse Hold, if you want your laundry to be spun at a speed different from the one proposed by the washing machine.

- **No Spin** (  )  
No spin option eliminates all the spin phases and increase the number of rinses.
- **Rinse Hold** (  )  
By selecting this option the water of the last rinse is not emptied out and the drum turns regularly to prevent the laundry creases.

The door is still locked to indicate that the water must be emptied out.

 The door stays locked with the water in the drum. To continue the cycle, you must press  (Start/Pause).

#### Time Manager

This option allows you to adjust the wash time. Press this touchpad repeatedly to decrease or increase the wash time according to the soil level of your wash. Use the table below as a guide.

Soil Level				
Light	>>	Medium	>>	Heavy
-	--	---	----	-----

#### Delay End ( ) Touchpad

Before you start the program, this option makes it possible to define the end of the washing program from minimum of 1 hour to maximum of 20 hours.

 If program duration is longer than 3 hours, minimum Delay End option starts from 4 hours.

Press the Delay End touchpad to choose the end time as you wish. The display shows the number of hours and the indicator beside the touchpad is on.

 This option must be selected after choosing the wash program, and before pressing the "Start/Pause" touchpad.

For example, if the program duration of your selected program is 3.20 hours and you define the "Delay End" time to 6 hours. This means your wash program will finish in 6 hours. (See diagram)

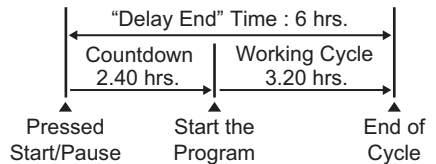

After selecting Delay End time, press Start/Pause touchpad to start the program. Machine will then countdown and update time on the display every hours until it reaches the starting point of the wash cycle.

If you wish to modify or cancel Delay End option after starting the program, follow the steps below:

- set the washing machine to PAUSE by pressing "Start/Pause" touchpad;
- deselect this option by pressing "Delay End" touchpad repeatedly till the display shows delay time "  ";
- press the "Start/Pause" to start the program.

## Hygienic Care (☁) Touchpad

Select this option to add approximately 30 minutes of tumbling in vapour after the rinse cycle. The indicator of this option will be on.

- Vapour may not necessarily be visible inside the drum during a vapour cycle. Vapour is created below the drum and allowed to naturally rise into the clothes.
- Vapour may not be present during the entire vapour cycle.
- At the end of the Vapour cycle, the clothes will be warmer, softer and detached from the drum.

### NOTE

If Vapour option is selected, rinse temperatures will be elevated.

During a vapour cycle, you may notice vapour exiting from the drain hose of the washing machine, this is normal and there is no cause for alarm.

## Prewash (⏮) Touchpad

Select this option if you wish your laundry to be pre-washed before the main wash. Use this option for heavy soil. The indicator of this option will be on.

When you set this function, put the detergent into the “⏮” compartment.

This function increases the program duration.

## Extra Rinse Touchpad

This option is recommended for people who are allergic to detergents, and in areas where the water is very soft.

Press this touchpad to add two rinse phases to a program. The indicator of this option will be on.

## 3.5 Settings

### Save Favourite (☆) Program

Program settings that are frequently used can be saved (e.g. Cotton, 60°C, 1200 rpm, with Prewash and Hygienic Care).

To program/re-program Favourite with your own selections and save them, proceed as follows:

1. Put machine in Stand-By mode.
2. Select your desired wash settings.
3. To save favourite program, press and hold "Hygienic Care (🌀)" touchpad about 2 seconds and you will hear that sound and "F R U" is flashing on the display.

To recall the favourite wash program, turn selector knob to "Favourite ☆" program. You will get acknowledgement on the display when the Favourite program is loaded.

### Child Safety Lock (🔒) Option

Your appliance is provided with CHILD SAFETY LOCK which permits you to leave the appliance unsupervised with the door closed without having to worry that children might be injured by or cause damage to the appliance.

 Set this option after pressing the Start/Pause touchpad.

#### To set "Child Lock" option:

- To activate the function, press and hold "Prewash" touchpad about 2 seconds until the display shows the icon "L 🔒".

 If you press any touchpad while Child Lock is activated, the icon "L 🔒" will flash on display 3 times along with buzzer sound.

 The touchpads are locked (except for the On/Off button).

 This function remains enabled even after the appliance is switched off.

- To deactivate the function, press and hold "Prewash" touchpad about 2 seconds until the display shows the icon "L 🔒".

### Enabling/Disabling End-Of-Wash Buzzer

This setting permits you to either enable or disable the buzzer at the end of the program. As an example, you might wish to disable this buzzer when you start a wash when going to bed, so that when the wash finished approximately 1 hour later, it will not disturb you through the night.

 Error warning beeps such as critical faults are not disabled.

- To disable the buzzer sound, press "Spin and Hygienic Care (🌀)" touchpads at the same time about 3 seconds, the icon "🔒 F" will show on display along with buzzer sound.
- To return to default configuration press these 2 touchpads at the same time about 3 seconds, the icon "🔒 🔒" will show on display along with buzzer sound.

### 3.6 Start/Pause ( ▷|| ) and Add Clothes ( ⇄ ) Touchpad

This touchpad has 2 functions:

#### 1. Start/Pause ( ▷|| )

After you have selected the desired program and options, press this touchpad to start the machine. The Start/Pause pilot light will stop flashing and remain lit. If you have selected a "Delay End" option, the countdown will begin and will be shown on the display.

To interrupt a program which is running, press this touchpad to pause the machine, the Start/Pause pilot light flashes.

To restart the program from the point at which it was interrupted, press this touchpad again, the Start/Pause pilot light will stop flashing.

#### 2. Add Clothes ( ⇄ )

**i** You can only add clothes when the icon " ⇄ " shown on the display.

To add clothes:

1. Pressing the "Start/Pause" touchpad to pause the program.
2. Wait for the machine to come to a complete stop before opening the door (wait for door lock " →□ " icon to turn off).
3. Add clothing and close the door.
4. Resume the program by pressing "Start/Pause" touchpad again.

## 4. BEFORE FIRST USE

### **i** NOTE

**During installation or before first use you may observe some water in the machine. This is a residual water left in the machine after a full functional test in the factory to ensure the machine is delivered to customers in perfect working order and is no cause for concern.**

1. Ensure that the electrical and water connections comply with the installation instructions.
2. Put 2 litres of water in the detergent compartment for washing phase. This activates the drain system.

3. Select a Cottons cycle at 90 °C, without any laundry in the machine, to remove any manufacturing residue from the drum and tub then start the machine.

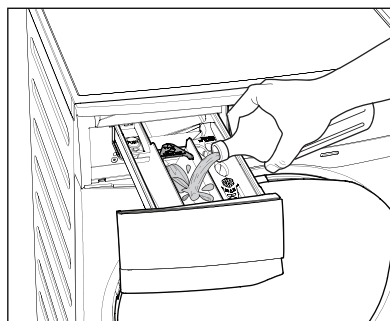



## 5. DAILY USE

### 5.1 Loading The Laundry

1. Turn the water tap on.
2. Connect the main plug to the main socket.
3. Press the On/Off button to turn on the washing machine. Turn the knob to set a program. The washing machine will propose a temperature and automatically select the spin value provided for the program you have chosen.

The selector knob can be turned either clockwise or counter-clockwise.

4. Check and remove objects (if there are any) that could be trapped in the fold.

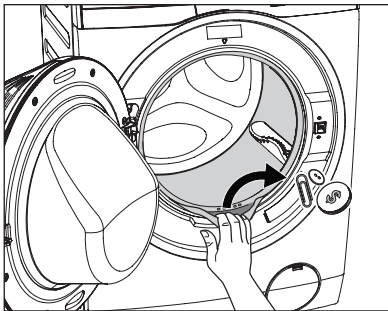

5. Place the laundry in the drum, one item at a time, shaking them out as much as possible. (Refer to page 21 "WASHING HINTS")

6. Close the door.

 Make sure that no laundry remains between the seal and the door.

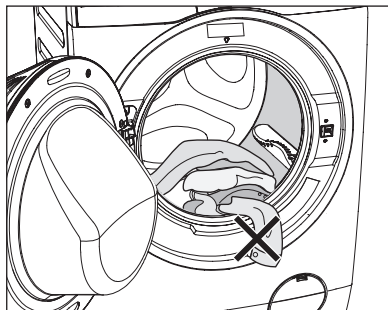



### 5.2 Using Detergent And Additives

 Please read "Detergents Type and Quantity of Detergent" on page 22 before use.

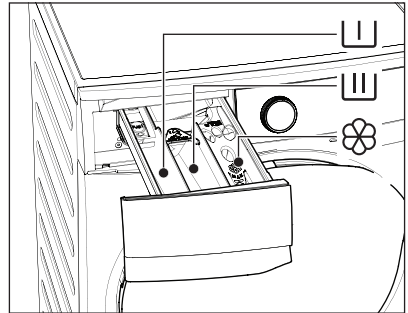
1. Detergent Dispenser Drawer  
The detergent dispenser is divided into three compartments.



-  Compartment "PREWASH"  
This compartment is only used for detergent when a "Prewash" option is selected.
-  Compartment "MAIN WASH"  
This compartment is used for detergent on all programs.

 Detergent flap

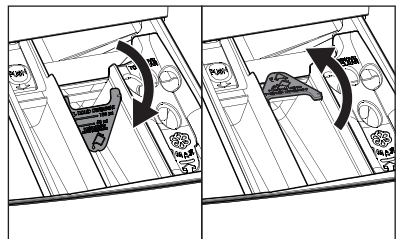

**Position down:** for liquid detergent.  
**Position up:** for powder detergent.

-  Compartment "SOFTENER"  
This compartment is used for fabric conditioner and starching agent.

**i NOTE: When you use the liquid detergent**

- Do not use gelatinous or thick liquid detergents.
- Do not put more liquid than the maximum level.
- Do not set the "Prewash" phase.
- Do not set the "Delay End".

2. Measure out the detergent and the fabric softener;

- Pull out the dispenser drawer until it stops.
- Measure out the amount of detergent required, pour it into the main wash compartment .

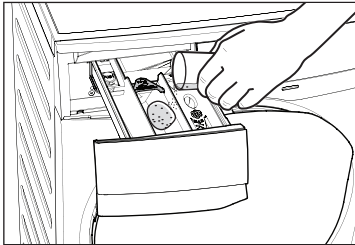

- If you wish to carry out the "Prewash" phase, pour it into the compartment marked .

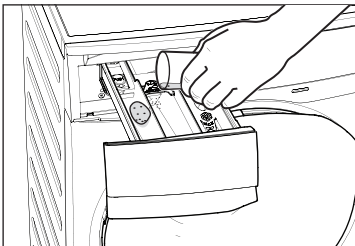

- If required, pour fabric softener into the compartment marked .

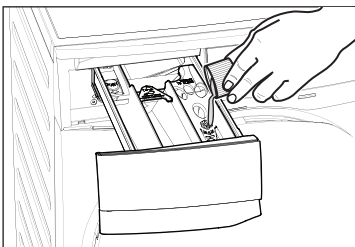

**i NOTE**

The softener amount used must not exceed the "MAX" mark in the drawer.

If you use thick softeners it is recommended to dilute with water.

- Close the drawer gently.

**i NOTE**

Residues of detergent, softener and water may remain in the dispenser. It is recommended to clean the dispenser regularly to remove any residue.

### 5.3 Options Setting

1. If you want your laundry to be spun or use temperature different from the one proposed by the washing machine, press "Spin" and "Temp" touchpads repeatedly to change the spin speed and temperature.

Press the option touchpads, if you want your laundry to be washed with special functions.

**i NOTE**

- Different functions can be combined which is dependent on the program selected.
- If an option is not compatible with the wash program selected, the symbol " - - - " will flash on display along with buzzer sound.

2. If you want to adjust washing time, press the "Time Manager" touchpad repeatedly to increase or decrease washing time. (See Time Manager guide on page 13)

If you want to define the end of the washing program, press the "Delay End" touchpad repeatedly to choose your washing machine working time.

## 5.4 Starting A Cycle (▷||)

To start a program, press the Start/Pause touchpad. The corresponding pilot light will stop flashing and a default program duration will be displayed on the screen.

After approx. 15 minutes from the start of a program:

- The appliance will automatically adjust the selected program duration according to the type and size of the load.
- The display will show adjusted program duration.

### NOTE

If you press any touchpad while a program is operating, the symbol “- - -” will flash on display along with buzzer sound. (except Start/Pause touchpad and On/Off button)

## 5.5 Interruption Of A Program

- To pause, press Start/ Pause. The indicator will start flashing.
- Press the Start/Pause again. The program will continue.

## 5.6 Changing A Program

Changing a running program is possible only by switching off the appliance.

- Press the “On/Off” button to cancel the program and to turn off the appliance.
- Press the “On/Off” button again to start the appliance.

Now you can set a new wash program and change any available options. Press Start/Pause to start the new program.

### NOTE

The appliance will not drain the water (except programs; Vapour Refresh, Spin, Rinse + Spin, Tub Clean).

## 5.7 Changing The Options

It may be possible to change some of the options after a wash program has started.

1. Press the touchpad Start/Pause. The indicator will start flashing.
2. If available change the options that you wish.
3. Press Start/Pause again. The program will continue.

## 5.8 Opening The Door

While a program or the Delay End is operating, the appliance door is locked and the display shows the indicator “”. First, set the machine to PAUSE by pressing the “Start/Pause” touchpad. Wait until the door lock indicator goes off, then the door can be opened.

If the door lock indicator “” does not disappear, this means that the machine is already heating and the water level is above the bottom edge of the door or the drum is turning. In this case the door CAN NOT be opened. If you need to open it, you must drain the water to open the door.

 **In case of emergency please refer to “Emergency door opening” on page 32.**

## 5.9 At The End Of The Program

- The appliance stops automatically.
- The acoustic signal will operate.
- The display will show “E rld”.
- The indicator of the touchpad Start/Pause goes off.
- The door lock indicator “” goes off.
- Remove the laundry from the appliance. Make sure that the drum is empty.
- Keep the door partly open, to prevent the mildew and odours.
- Turn off the water tap.

**i NOTE**

At the end of the program, the time remaining can suddenly decrease from 7 minutes or less to 0 due to the overestimated total program time during the load sensing phase. In some cases (with perfectly balanced load) the program time can be shorter than the time estimated after the load sensing phase is completed. This is a normal behavior of the machine and not a cause for concern as it does not compromise its performance.

### 5.10 When The Washing Program Is Completed, But There Is Water In The Drum (Option “Rinse Hold ” is used)

- The drum turns regularly to prevent the creases in the laundry.
- The indicator “Start/Pause” flashes to remind you to drain the water.
- The door lock indicator “ ” is on. The door stays locked.

**i You must drain the water to open the door.****To drain the water:**

1. Press the “Start/Pause  ” touchpad. The appliance drains the water and spins with the maximum spin speed for selected program.

**Alternatively**, before pressing the “Start/Pause” touchpad, you can press the “Spin ” touchpad to change the spin speed. You can select “No Spin ( )”, if you want the machine to only drain the water.

2. When the program is completed and the door lock indicator “ ” goes off, you can open the door.
3. Press the “On/Off” button to deactivate the appliance.

**i NOTE**

After approximately 18 hours, if you do not press Start/Pause touchpad, the appliance will drain and spin automatically (except for “Wool” program) .

### 5.11 AUTO Off Mode

The AUTO Off mode automatically deactivates the appliance to decrease the energy consumption when:

- You do not press any buttons for 5 minutes before you press “Start/Pause”.
  - Press the “On/Off” button to activate the appliance again.
- After 5 minutes from the end of the washing program.
  - Press the “On/Off” button to reactivate the appliance. Display will show the end of the last wash.
  - Press any touchpad again to show the last wash program.

## 6. WASHING HINTS

### 6.1 Sorting The Laundry

Follow the wash code symbols on each garment label and the manufacturer's washing instructions. Sort the laundry as follows: whites, coloureds, synthetics, delicates, woollens.

### 6.2 Temperatures

Temp	Soil level
90°C	For normally soiled white cottons and linen (e.g. tea cloths, towels, tablecloths, sheets...).
60°C 50°C	For normally soiled, colourfast garments (e.g. shirts, night dresses, pajamas....) in linen, cotton or synthetic fibres and for lightly soiled white cotton (e.g. underwear).
40°C 30°C Cold	For delicate items (e.g. net curtains), mixed laundry including synthetic fibres and woollens bearing the label pure new wool, machine washable, non-shrink.

### 6.3 Before Loading The Laundry

- Make sure that no metal objects are left in the laundry (e.g. coin, hair clips, safety pins, pins).



- Button up pillowcases, close zip fasteners, hooks and poppers. Tie any belts or long tapes.

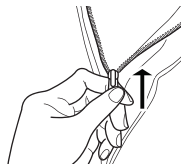

- Wash bras, pantyhose and other delicates in a mesh laundry bag, which you can purchase from your supermarket.



- Make sure that you wash lint collectors separately from lint producers.
- Never wash whites and coloured fabrics together. Whites may lose their "whiteness" in the wash.
- New coloured items may run in the first wash; they should therefore be washed separately the first time.
- Remove persistent stains before washing.
- Rub particularly soiled areas with a special detergent or detergent paste. Treat curtains with special care. Remove hooks or tie them up in a bag or a net.

### 6.4 Maximum Loads

Recommended loads are indicated in the program charts on page 11.

General rules:

Clothes Load	Quantity
Cotton, linen	drum full but not too tightly packed;
Synthetics	drum no more than half full;
Delicate fabrics and woollens	drum no more than one third full.

Washing a maximum load makes the most efficient use of water and energy. For heavily soiled laundry, reduce the load size.

### 6.5 Removing Stains

Stubborn stains may not be removed by just water and detergent. It is therefore advisable to treat them prior to washing.

**Blood:** treat fresh stains with cold water. For dried stains, soak overnight in water with a special detergent then rub in the soap and water.

**Oil based paint:** moisten with benzine stain remover, lay the garment on a soft cloth and dab the stain; treat several times.

**Dried grease stains:** moisten with turpentine, lay the garment on a soft surface and dab the stain with the fingertips and a cotton cloth.

**Rust:** oxalic acid dissolved in hot water or a rust removing product used in cold water. Be careful with rust stains which are not recent since the cellulose structure will already have been damaged and the fabric tends to hole.

**Mould stains:** treat with bleach, rinse well (whites and fast coloureds only).

**Grass:** soap lightly and treat with bleach (whites and fast coloureds only).

**Ball point pen and glue:** moisten with acetone (\*), lay the garment on a soft cloth and dab the stain.

**Lipstick:** moisten with acetone (\*) as above, then treat stains with methylated spirits. Remove any residual marks from white fabrics with bleach.

**Red wine:** soak in water and detergent, rinse and treat with acetic or citric acid, then rinse. Treat any residual marks with bleach.

**Ink:** depending on the type of ink, moisten the fabric first with acetone (\*), then with acetic acid; treat any residual marks on white fabrics with bleach and then rinse thoroughly.

**Tar stains:** first treat with stain remover, methylated spirits or benzine, then rub with detergent paste.

(\*) do not use acetone on artificial silk.

## 6.6 Detergents Type And Quantity Of Detergent

Low sudsing detergent is required for this washing machine to prevent oversudsing problems, unsatisfactory washing result and harm to the machine.

Low sudsing detergents designed for front load washing machines are labelled "Front Loading", "high efficiency", "HE", such as Cold Power for Front Loaders or "Matic".

**Do not use wrong types of detergent, such as Top Loading, Handwash detergent or Soap-Based products in your frontload washing machine. This can result in excessive suds, longer cycle time, low spin speeds, poor rinsing and overloading of the motor.**

### Quantity of detergent to be used

The choice of detergent and use of correct quantities not only affects your wash performance, but also helps to avoid waste and protect the environment. Although biodegradable detergents contain substances which in large quantities can upset the delicate balance of nature.

The choice and quantity of detergent will depend on ;

- type of fabric (delicates, woollens, cottons, etc.) ;
- the colour of clothes ;
- size of the load ;
- degree of soil ;
- wash temperature ; and
- hardness of the water used.

Water hardness is classified by so-called "degrees" of hardness.

Information on hardness of the water in your area can be obtained from the relevant water supply company, or from your local authority.

You may have to try using the detergent quantity as per manufacturers' instructions then compare the wash result to the list below and adjust the amount of detergent for your future washes accordingly.

**Not enough detergent causes:**

- the washload to turn grey,
- greasy clothes.

**Too much detergent causes:**

- sudsing,
- reduced washing effect,
- inadequate rinsing.

































**Use less detergent if:**

- you are washing a small load,
- the laundry is lightly soiled,
- large amounts of foam during washing.

---

## 7. INTERNATIONAL WASH CODE SYMBOLS

 These symbols appear on fabric labels, in order to help you choose the best way to treat your laundry.

 <b>Energetic wash</b>	 Max. wash temperature 95 °C	 Max. wash temperature 60 °C	 Max. wash temperature 40 °C	 Max. wash temperature 30 °C	 Hand wash	 DO NOT wash at all
 <b>Delicate wash</b>			 			
 <b>Bleaching</b>	 Bleach in cold water			 DO NOT bleach		
 <b>Ironing</b>	 Hot iron max. 200 °C	 Warm iron max. 150 °C	 Lukewarm iron max. 110 °C	 DO NOT iron		
 <b>Dry cleaning</b>	 Dry cleaning in all solvents	 Dry cleaning in perchlorethylene, petrol, pure alcohol, R 111 & R 113	 Dry cleaning in petrol, pure alcohol and R 113	 DO NOT dry clean		
 <b>Drying</b>	 Flat	 On the line	 On clothes hanger	 High temperature	 Low temperature	 DO NOT tumble dry

---

## 8. CARE AND CLEANING

### **WARNING!**

You must **DISCONNECT** the appliance from the electricity supply, before you can carry out any cleaning or maintenance work.

### 8.1 External Cleaning

Clean the appliance only with soap and warm water. Fully dry all the surfaces.

### **CAUTION!**

**Do not use alcohol, solvents or chemical products.**

### 8.2 Descaling

The water we use normally contains lime. It is a good idea to periodically use a water softening powder in the machine.

Do this separately from any laundry washing, and according to the softening powder manufacturer's instructions.

This will help to prevent the formation of lime deposits.

### 8.3 After Each Wash

Leave the door open for a while. This helps to prevent mould and stagnant smells forming inside the appliance.

Keeping the door open after a wash will also help to preserve the door seal.

### 8.4 Maintenance Wash With "Tub Clean" Program

With the use of low temperature washes it is possible to get a build up of residues inside the drum.

We recommend to use "Tub Clean" program to clean the drum regularly to remove any residue.

### To run a maintenance wash:

- The drum should be empty of laundry.
- Select the "Tub Clean" program.
- Press Start/Pause to start the program.

### 8.5 Cleaning The Dispenser Drawer

The washing powder and additive dispenser drawer should be cleaned regularly.

Remove the drawer by pressing the catch downwards and by pulling it out.

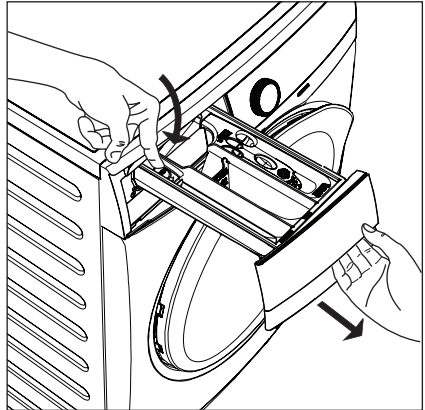

To aid cleaning, the top part of the additive compartment should be removed.

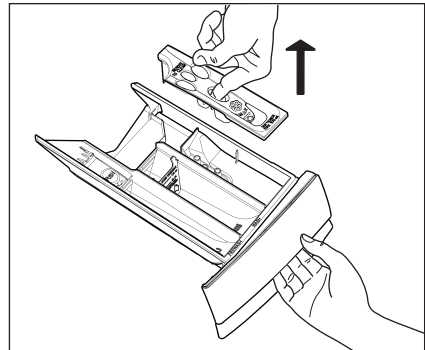



Flush it out under a tap to remove any traces of accumulated powder.

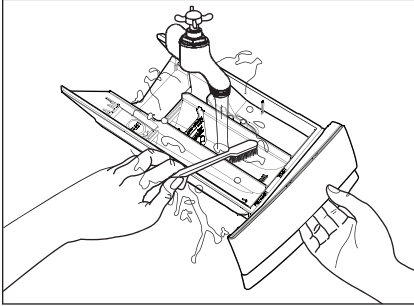

## 8.6 Cleaning The Drawer Recess

Having removed the drawer, use a small brush to clean the recess, ensuring that all washing powder residue is removed from the upper and lower part of the recess. Replace the drawer and run the rinse program without any clothes in the drum.

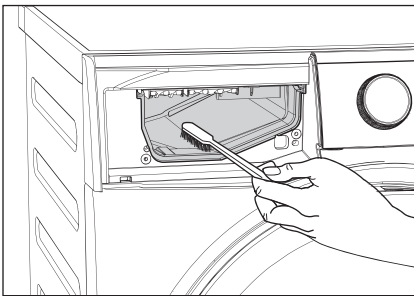

## 8.7 Cleaning The Pump

**i** Regularly examine the drain pump and make sure that it is clean.

**Clean the pump if:**

- The appliance does not drain the water.
- The drum cannot turn.
- The appliance makes an unusual noise because of the blockage of the drain pump.
- The display shows an alarm code because of the problem with water drain.

### **!** WARNING!

1. Disconnect the mains plug from the mains socket.
2. Do not remove the filter while the appliance is operating. Do not clean the drain pump if the water in the appliance is hot. The water must be cold before you clean the drain pump.

**To clean the drain pump:**

1. Open the drain pump door.

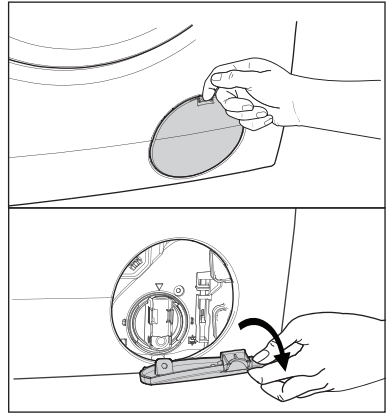

2. Place a suitable water container below the recess of the drain pump to collect the water that flows out.

Press the two levers and pull forward the drainage duct to let the water flow out.

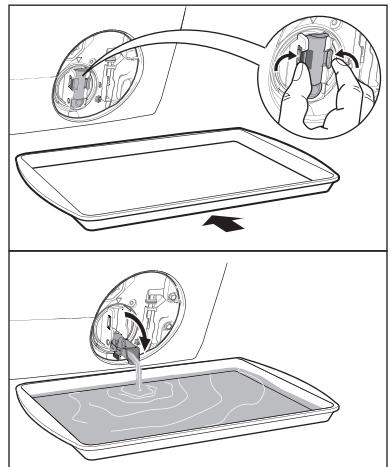

3. When the container is full of water, put the drainage duct back again and empty the container. Do step 2, 3 again and again until no more water flows out from the drain pump.

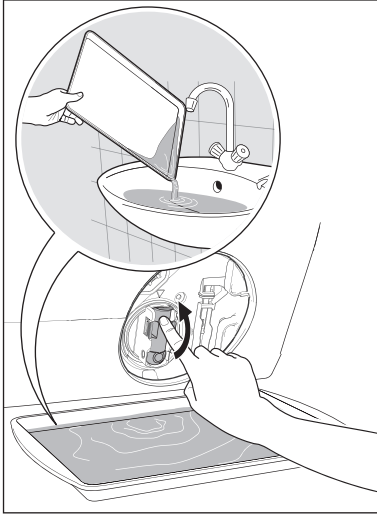

4. Push back the drainage duct and turn the filter counter-clockwise to remove it.

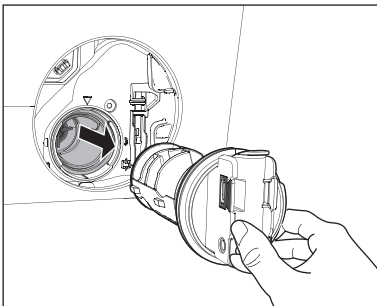
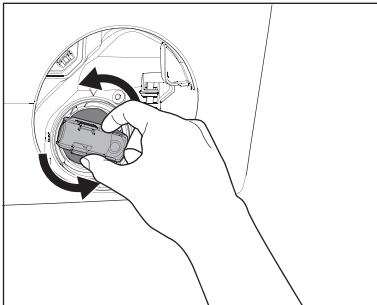

5. Remove fluff and objects from the pump (if there are any).

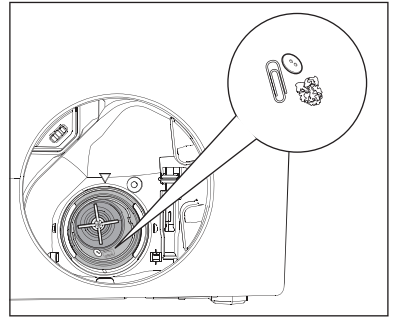

6. Make sure that the impeller of the pump can turn. If this does not occur, contact the service centre.

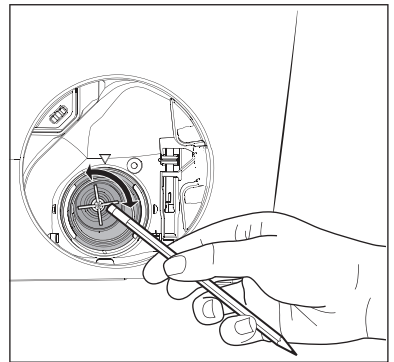

7. Clean the filter under the water tap.

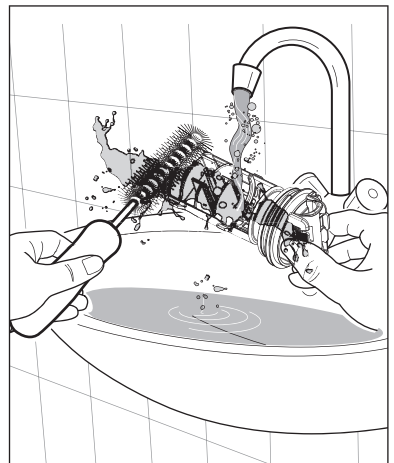

- Put the filter back into the housing with exposed section facing up. Make sure that you correctly tighten the filter to prevent leakages.

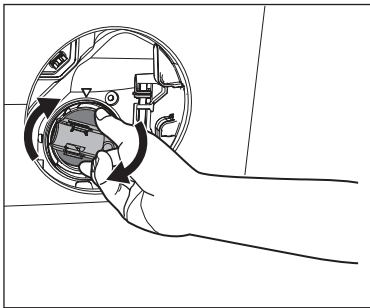
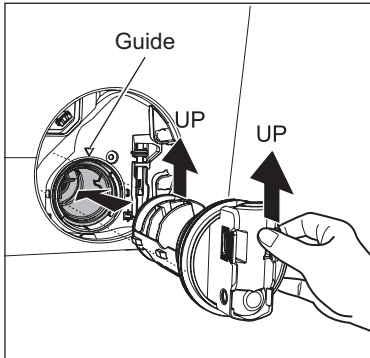

- Close the drain pump door.

## 8.8 Cleaning The Water Inlet Filter

If your water is very hard or contains traces of lime deposit, the water inlet filter may become clogged. It is therefore a good idea to clean it from time to time.

### To clean the water inlet filters:

- Close the water tap.
- Remove the water inlet hose from the water tap.

- Clean the filter in the inlet hose with a stiff brush.

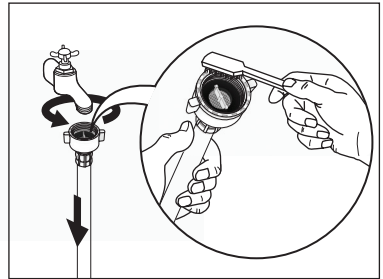

- Remove the inlet hose behind the appliance.

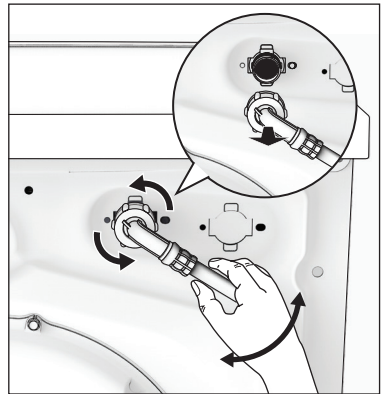

- Clean the filter in the valve with a stiff brush or a towel.

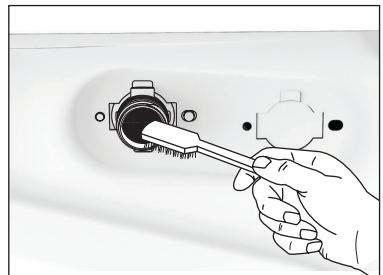

- Install the inlet hose again. Make sure that the couplings are tight to prevent leakages.
- Open the water tap.

## 8.9 Frost Precautions

If the appliance is installed in an area where the temperature can be less than 0 °C, remove the remaining water from the inlet hose and the drain pump.

### Emergency Drain

1. Disconnect the main plug from the main socket. Turn off the water tap.
2. Remove the water inlet hose.
3. Remove the drain hose from the rear support and unhook it from sink or spigot.

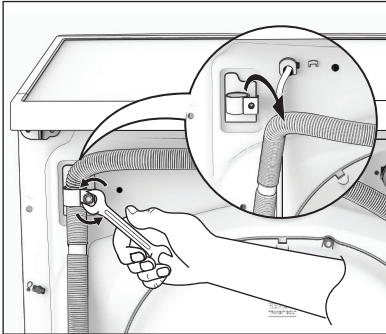

4. Put the end of the drain and inlet hose in a container. Let the water flow out of the hoses.

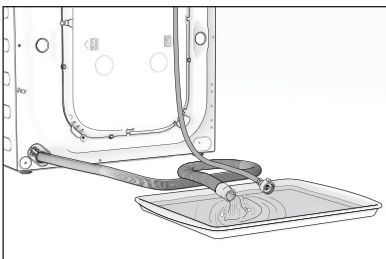

5. When no more water flows, install the inlet hose and the drain hose again.



#### NOTE

Make sure that the temperature is more than 0 °C before you use the appliance again.

## 9. TROUBLESHOOTING

### 9.1 Possible Failures

Certain problems are due to lack of simple maintenance or oversights, which can be solved easily without calling out an engineer. Before contacting your local Service Centre, please check trouble-shooting below.

Once the problem has been eliminated, press the Start/Pause button to restart the program. If after all checks, the problem persists, contact your local Service Centre.



**WARNING!** Deactivate the appliance before you do the checks.

#### Alarm Code:

<b>E10</b>	The appliance does not fill with water properly.
<b>E20</b>	The appliance does not drain the water.
<b>E40</b>	The appliance door is open or not closed correctly. Please check the door!
<b>EHO</b>	The main supply is unstable. Wait until the main supply is stable.
<b>E91</b>	No communication between electronic elements of the appliance. Switch off and switch on again.

Malfunction	Possible cause	Solution
<b>Machine does not start:</b>	The door has not been closed. (Error code: E40)	Close the door firmly.
	The plug is not properly inserted into the power socket.	Insert the plug into the power socket.
	There is no power at the socket.	Please check your domestic electrical installation.
	The Start/Pause touchpad has not been pressed.	Press the Start/Pause touchpad.
	The "Delay End" has been selected.	If the laundry are to be washed immediately, cancel the "Delay End".
	The Main supply is unstable. (If EHO appears on the display.)	Wait until the main supply is stable. Appliance will start automatically.
<b>Machine does not fill the water:</b>	The water tap is closed. (Error code: E10)	Open the water tap.
	The inlet hose is squashed or kinked. (Error code: E10)	Check the inlet hose connection.
	The filter in the inlet hose is blocked. (Error code: E10)	Clean the water inlet hose filter.
	The door is not properly closed. (Error code: E40)	Close the door firmly.
<b>Machine fills then empties immediately:</b>	The end of the drain hose is too low. (Error code: E10)	Refer to relevant paragraph in "water drainage" section.

<b>Malfunction</b>	<b>Possible cause</b>	<b>Solution</b>
<b>Machine does not empty and/or does not spin:</b>	The drain hose is squashed or kinked. (Error code: E20)	Check the drain hose connection.
	The drain pump is clogged. (Error code: E20)	Clean the drain filter.
	The option "Rinse Hold" has been selected.	Press Start/Pause touchpad to drain the water or select spin program.
	The laundry is not evenly distributed in the drum.	Pause the machine and redistribute laundry manually.
<b>There is water on the floor:</b>	Too much detergent or unsuitable detergent (creates too much foam) has been used.	Reduce detergent quantity and use correct type of detergent (refer page 22).
	Check whether there are any leaks from one of the inlet hose fittings. It is not always easy to see this as the water runs down the hose; check to see if it is damp.	Check the water inlet hose connection.
	The drain hose is damaged.	Call Service.
<b>Unsatisfactory washing results:</b>	Too little detergent or unsuitable detergent has been used.	Increase detergent quantity or use different detergent (refer page 22).
	Stubborn stains have not been treated prior to washing.	Use commercial products to treat the stubborn stains.
	The correct temperature was not selected.	Check if you have selected the correct temperature.
	Excessive laundry load.	Reduce load.
<b>The door will not open:</b>	The program is still running.	Wait until the end of cycle.
	There is water in the drum.	You must drain the water to open the door (refer "Opening The Door" on page 19).
	This problem may be caused by a failure of the appliance.	Contact Service. If you need to open the door, please read carefully "Emergency door opening" on page 32.
<b>Machine vibrates or is noisy:</b>	The transit bolts and packing have not been removed.	Check the correct installation of the appliance.
	The support feet have not been adjusted.	Check the correct levelling of the appliance.

<b>Malfunction</b>	<b>Possible cause</b>	<b>Solution</b>
<b>Machine vibrates or is noisy:</b>	The laundry is not evenly distributed in the drum.	Pause the machine and redistribute laundry manually.
	There is very little laundry in the drum.	Load more laundry.
	Unstable floors eg. wooden floors.	Refer to relevant paragraph in "Positioning" section.
<b>Cycle time longer than displayed:</b>	Detergent over dose.	Reduce the detergent quantity or use another one. (Refer page 22 "Detergents Type And Quantity Of Detergent").
	Machine unbalance.	Redistribute laundry manually in the drum and start the spin phase again.
<b>The cycle is shorter than the time displayed.</b>	The appliance calculated a new time according to the laundry load.	
<b>Spinning starts late or machine does not spin:</b>	<p>The electronic unbalance detection device has cut in because the laundry is not evenly distributed in the drum. The laundry is redistributed by reverse rotation of the drum.</p> <p>This may happen several times before the unbalance disappears and normal spinning can resume. If, after 10 minutes, the laundry is still not evenly distributed in the drum, the machine will not spin. In this case, redistribute the load manually and select the spin program.</p>	Pause the machine and redistribute laundry manually.
<b>Machine makes an unusual noise:</b>	Machine not installed properly.	Make sure the levelling of the appliance is correct. Refer to "Installation".
	Transit bolts or packaging not removed.	Make sure that the packaging and/or the transit bolts are removed. Refer to "Unpacking".
	The load may be too small.	Add more laundry in the drum.
<b>No water is visible in the drum:</b>	Machines based on modern technology operate very economical-ly using very little water without affecting performance.	

### **i** NOTE

If you are unable to identify or solve the problem, contact our service centre. Before calling service centre, make a note of the model, serial number and purchase date of your machine: the Service Centre will require this information.

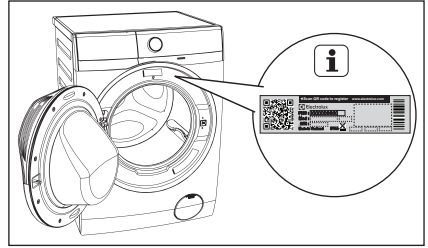

## 9.2 Emergency Door Opening

In case of power failure or appliance failure, the appliance door remains locked. The wash program continues when power is restored. If the door remains locked in case of failure, it is possible to open it using the emergency unlock feature.

**Before opening the door:**

### **!** WARNING!

**Make sure that the water temperature and the laundry are not hot. Wait until they cool down if necessary.**

**Make sure that the water level inside the drum is not too high. If necessary, perform an Emergency Drain (see page 28).**

**Make sure that the drum is not rotating. Wait until the drum stops rotating if necessary.**

**To open the door proceed as follows:**

1. Press the On/Off button to switch the appliance off.
2. Disconnect the mains plug from the mains socket.
3. Open the filter cover.
4. Using a suitable tool to pulling the emergency unlock strap (red strap) downward twice (you will hear "click" sound) and hold it, at the same time pull the door handle to open the door.

If the door cannot open while holding the strap, try to release it then open the door.

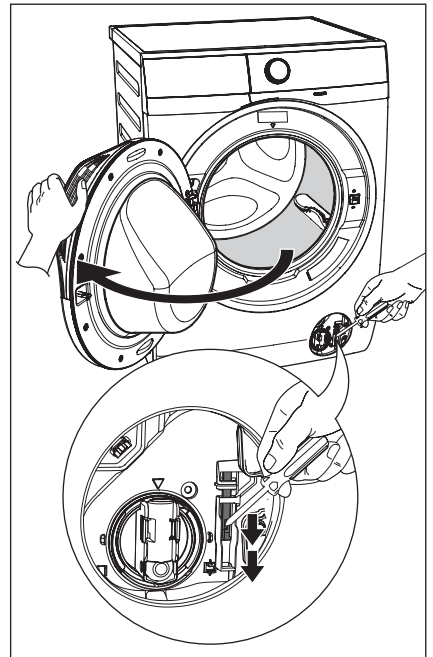

5. Take out the laundry.
6. Close the filter flap.



## 10. TECHNICAL DATA

<b>Dimensions (Height / Width / Depth)</b>	EWF8024R5WB, EWF8024R5SB : 850 x 600 x 575 mm EWF9024R5WB, EWF9024R5SB : 850 x 600 x 659 mm		
<b>Power supply (Voltage / Frequency)</b>	220 - 240 V~ / 50 Hz		
<b>Total power absorbed</b>	2000 W		
<b>Water supply pressure (Maximum / Minimum)</b>	0.8 MPa / 0.05 MPa		
<b>Maximum dry clothes capacity</b>	<b>Program</b>	<b>EWF8024R5WB, EWF8024R5SB</b>	<b>EWF9024R5WB, EWF9024R5SB</b>
	<b>Cottons</b>	<b>Max.<sup>1)</sup></b>	<b>Max.<sup>1)</sup></b>
	<b>Mixed</b>	4 kg	4 kg
	<b>Delicates</b>	4 kg	4 kg
	<b>Bedding</b>	3 kg	3 kg
	<b>Sports</b>	4 kg	4 kg
	<b>Energy Saver</b>	<b>Max.</b>	<b>Max.</b>
	<b>Tub Clean</b>	-	-
	<b>Spin</b>	<b>Max.</b>	<b>Max.</b>
	<b>Rinse + Spin</b>	<b>Max.</b>	<b>Max.</b>
	<b>Baby Care</b>	4 kg	4 kg
	<b>Wool</b> 	1.5 kg	1.5 kg
	<b>Quick 15</b>	1.5 kg	1.5 kg
	<b>Daily 39</b>	4 kg	5 kg
<b>Full Wash 60 Favourite</b>	<b>Max.</b> -	<b>Max.</b> -	
<b>Spin speed (Maximum / Minimum)</b>	1200 rpm / 400 rpm		

1) Maximum capacity depended on the model of the Washing Machine (see defined on the control panel).

## 11. INSTALLATION

### 11.1 Unpacking

#### CAUTION!

All transit bolts and packing must be removed before using the appliance.

You are advised to keep all transit devices so that they can be refitted if the machine ever has to be transported again.

1. Use gloves. Cut and remove four cut out straps as shown.

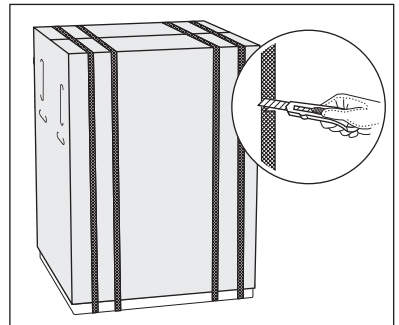

2. Remove the carton box. Remove the polystyrene packaging materials. Remove the plastic bag which cover the machine.

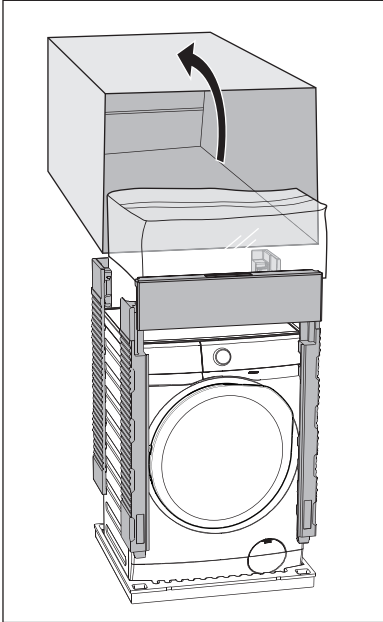

3. Open the door. Remove the polystyrene piece from the door seal and all the items from the drum.

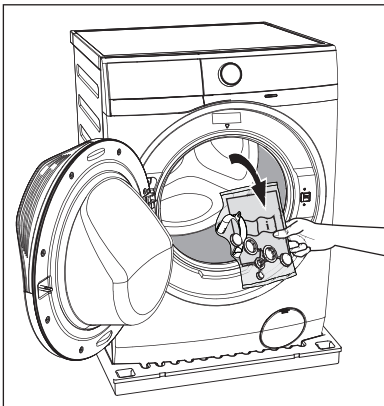

4. Put one of the polystyrene packaging elements on the floor behind the appliance. Carefully put down the appliance with the rear side on it. Make sure not to damage the hoses.

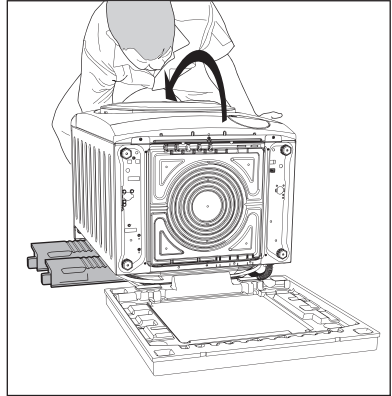

5. Remove the polystyrene base.

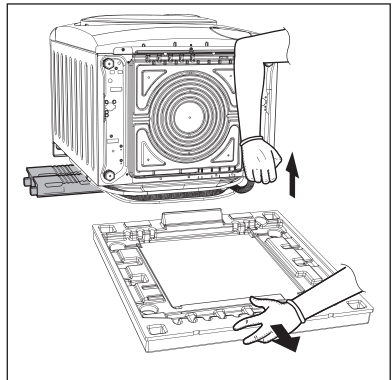

6. Pull up the appliance in vertical position.
7. Remove the power supply cable and the drain and inlet hoses from the hose holders (A) on the rear of the appliance.

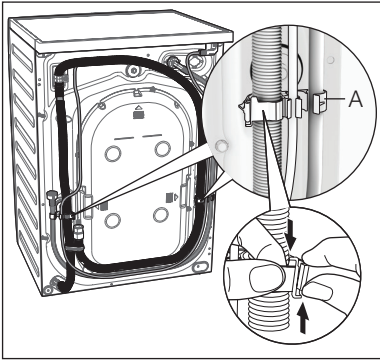

8. Remove the three transit bolts.
9. Pull out the plastic spacers.

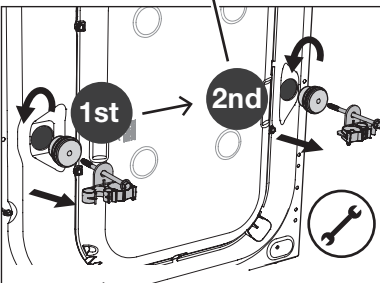
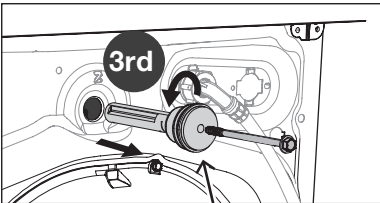

10. Put the plastic caps in the holes (X3). You can find these caps in the user manual bag.

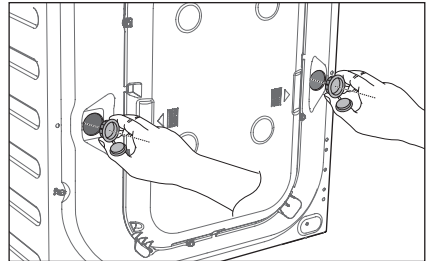
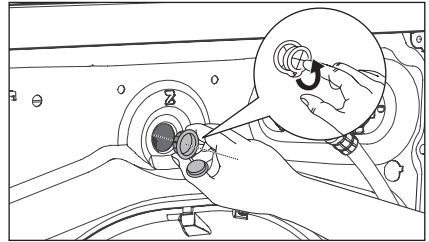
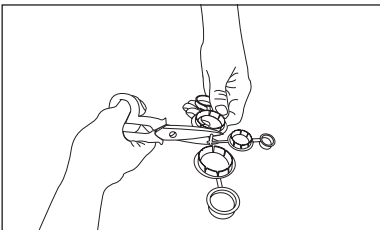

## 11.2 Positioning

It is important that your washing machine stands firm and leveled on the floor to ensure correct operation. The appliance must not be installed behind a lockable door, a sliding door or a door with a hinge on the opposite side to avoid restricting the washing machine door.

Use a spirit level on the top and side of the washing machine to check the levels.

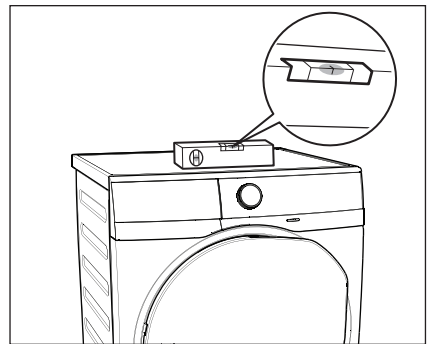

If you do not have a spirit level, as a guide use the edge of a door frame, cupboard or bench to check that the washing machine is leveled.

Loosen or tighten the feet to adjust the level. A correct adjustment of the appliance level prevents vibration, noise and the movement of the appliance when in operation.

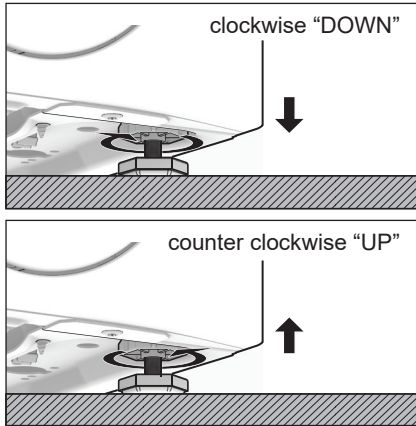

When the washing machine is levelled, try to rock it from corner to corner. If it does rock, adjust the legs again until it is levelled and does not rock.

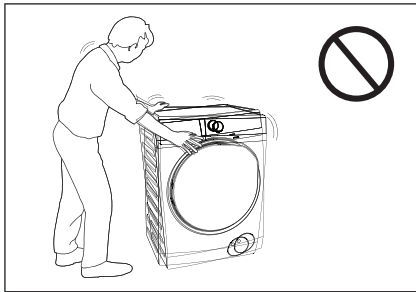

Never place cardboard, wood or similar materials under the machine to compensate for any unevenness in the floor. Install the machine on a flat hard floor. Make sure that air circulation around the machine is not impeded by carpets, rugs etc.

Check that the machine does not touch the wall or cupboard units.

### 11.3 Water Inlet

Connect the water inlet hose to a tap with 3/4" BSP thread. Use the hose supplied with the washing machine. **DO NOT USE OLD HOSES.**

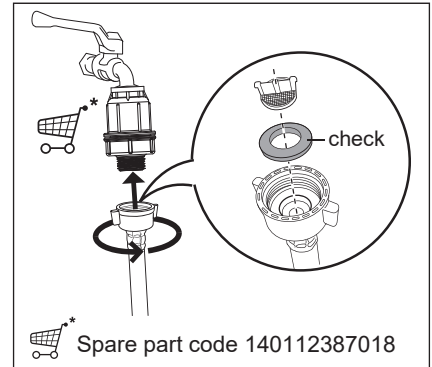

The inlet hose must not be lengthened. If it is too short and you do not wish to move the tap, you will have to purchase a new, longer hose specially designed for this type of use.

Loosen the ring nut to angle the hose to the left or right depending on the position of your water tap. Do not place the inlet hose downwards. After positioning the inlet hose, be sure to tighten the ring nut again to prevent leaks.

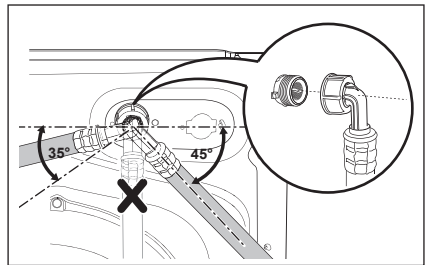

### 11.4 Water Drainage

The end of the drain hose can be positioned in three ways:

- **Hooked over the edge of a sink,** using the plastic hose guide supplied with the machine.

**Fitting Hose Guide**

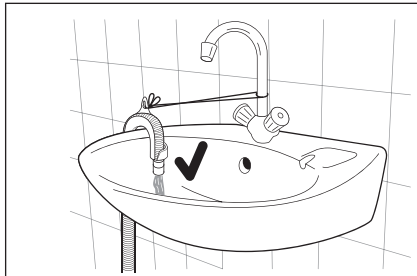
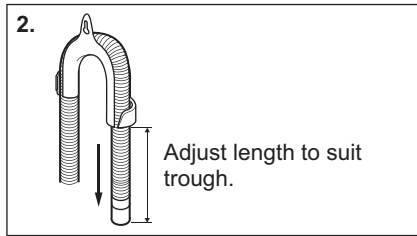
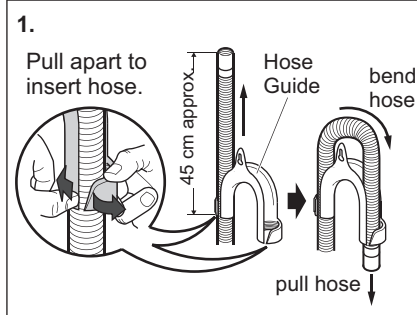

In this case, make sure the end cannot come unhooked when the machine will be emptied. This could be done by tying it to the tap with a piece of string or attaching it to the wall.

• **In a sink, drain pipe branch.**

This branch must be above the trap so that the bend is at least 60 cm above the ground.

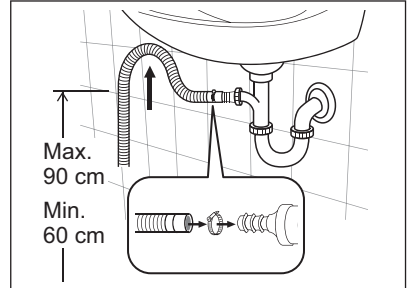

Push the drain hose onto the spigot and secure with a clip, ensure a loop is formed in the drain hose to prevent waste from the sink entering the appliance.

• **Directly into a drain pipe,** at a height of not less than 60 cm and not more than 90 cm.

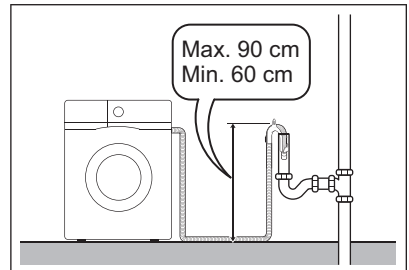

The end of the drain hose must always be ventilated, i.e. the inside diameter of the drain pipe must be larger than the outside diameter of the drain hose.

The drain hose must not be twisted or curled. Run it along the floor; only the part near the drainage point must be raised.

For the correct functioning of the machine, the drain hose must remain hooked on the proper support piece situated on the top part of back side of the appliance.

## 11.5 Electrical Connection

This machine is designed to operate on a 220 - 240 V, single-phase, 50 Hz supply.

**“An incorrect power supply may void your warranty.”**

Check that your domestic electrical installation can take the maximum load required (2.0 kW), also taking into account any other appliances in use.



### CAUTION!

**Connect the machine to an earthed socket outlet.**



**The manufacturer declines any responsibility for damage or injury through failure to comply with the above safety precaution.**



**Should the appliance power supply cable need to be replaced, this shall be carried out by our Service Centre.**

When the appliance is installed, the power supply cable must be easily accessible.

## 12. ENVIRONMENT CONCERNS

### 12.1 Packaging Materials



The materials marked with the symbol  are recyclable.

>PE<=polyethylene  
>PS<=polystyrene  
>PP<=polypropylene

This means that they can be recycled by disposing them properly in appropriate collection containers.

### 12.2 Old Machine

Use authorized disposal sites for your old appliance. Help to keep your country tidy.

The symbol  on the product or on its packaging indicates that this product may not be treated as household waste.

Instead it shall be handed over to the applicable collection point for the recycling of electrical and electronic equipment. By ensuring this product is disposed of correctly, you will help prevent potential negative consequences for the environment and human health, which could otherwise be caused by inappropriate waste handling of this product.

For more detailed information about recycling of this product, please contact your local city office, your household waste disposal service or the shop where you purchased the product.

### 12.3 Ecological Hints

To save water, energy and to help protect the environment, we recommend that you follow these tips:

- Normally soiled laundry may be washed without prewashing in order to save detergent, water and time (the environment is protected too!).
- The machine works more economically if it is fully loaded.
- With adequate pre-treatment, stains and limited soiling can be removed; the laundry can then be washed at a lower temperature.
- Measure out detergent according to the water hardness, the degree of soiling and the quantity of laundry being washed.

**!** External inlet water filter are not designed to be used with hot water.

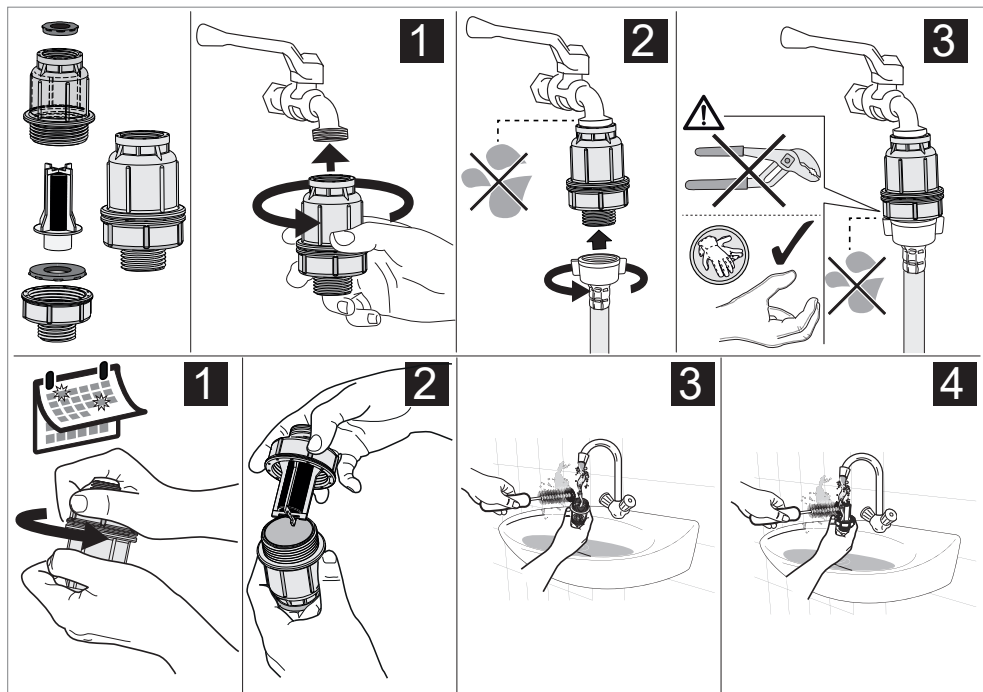

www.electrolux.com



G0043652-001-A24308967

